

FIGURE 1

APPROVAL	SIGN	DATE
TOOLING MGR		
ENGG MGR		
OPERATIONS MGR		

FOR REVISION UPDATE PLEASE REFER TO HISTORY OF CHANGES.

 **Carsem** Your Technology Partner

REV  
A

DWG NO: - MLPM-CPOD-0004	
APP'D	-
CHECKED	CC YIP
DESIGNED	-
DRAWN	KC LAU

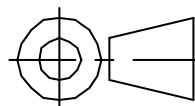

FILE:- MLPM-CPOD-0004-RevA
MLP MICRO PACKAGE OUTLINE ISOLATED EXPOSED PAD
PAGE : 1 of 7

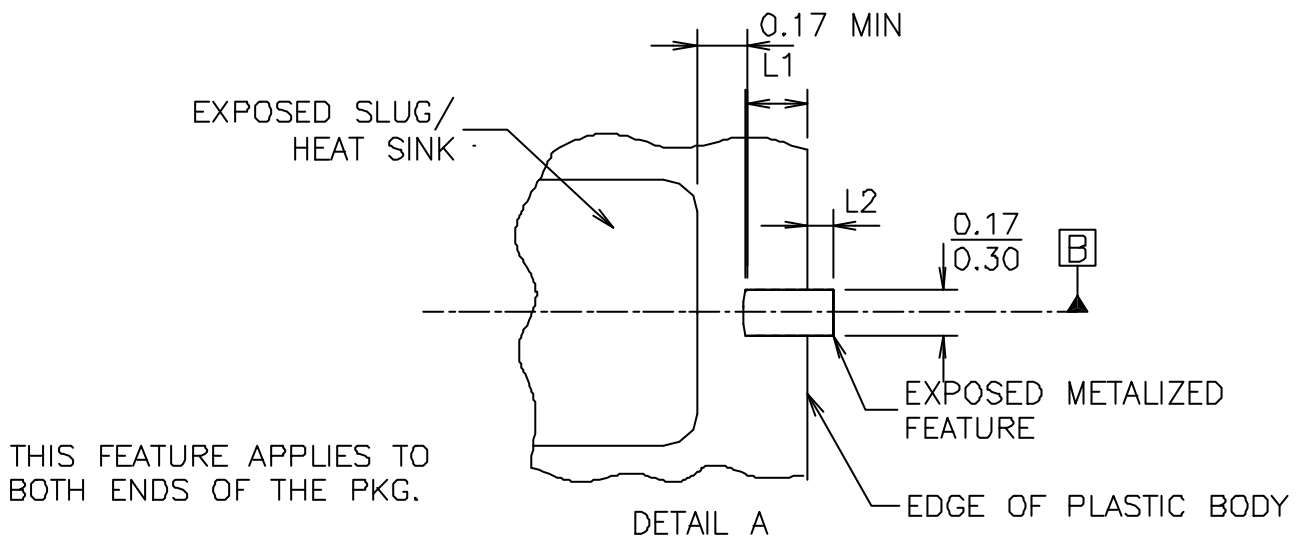
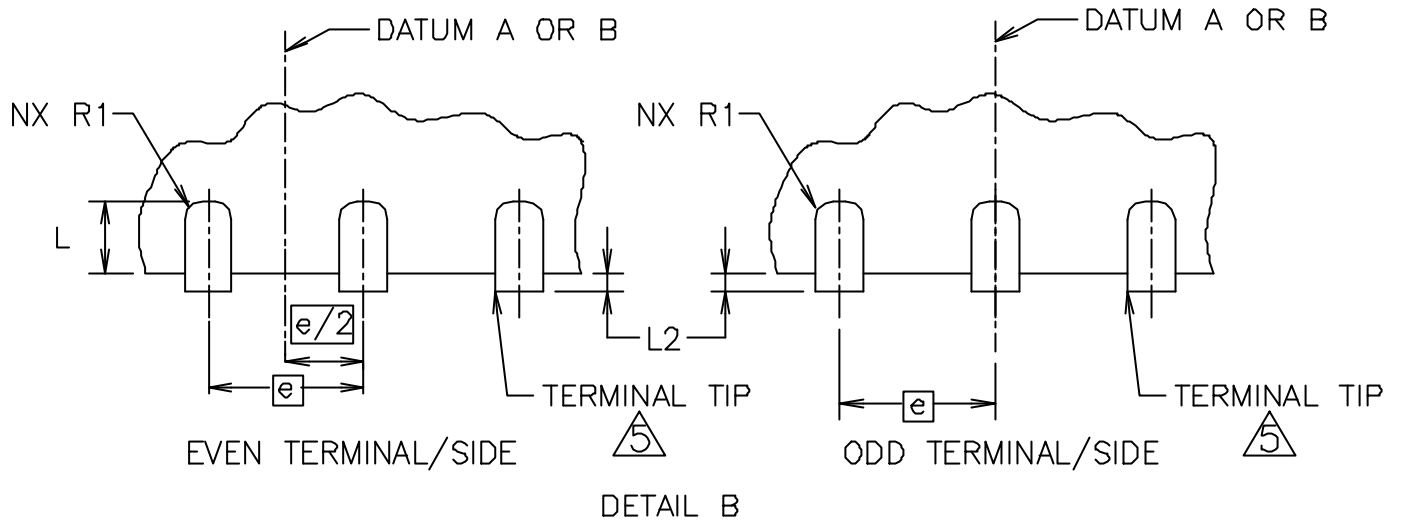

FOR REVISION UPDATE PLEASE REFER TO HISTORY OF CHANGES.

 **Carsem** Your Technology Partner

REV  
A

DWG NO:	- MLPM-CPOD-0004	
APP'D	-	
CHECKED	CC YIP	
DESIGNED	-	
DRAWN	KC LAU	

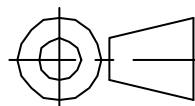

FILE:-	MLPM-CPOD-0004-RevA
MLP MICRO PACKAGE OUTLINE ISOLATED EXPOSED PAD	
PAGE 12 of 7	

TABLE 1



VARIATION DESIGNATORS							
FIRST DIGIT CODE		SECOND DIGIT CODE		THIRD DIGIT CODE		FOURTH DIGIT CODE	
OVERALL HEIGHT		BODY LENGTH		BODY WIDTH		TERMINAL PITCH	
A	LETTER CODE	D	LETTER CODE	E	LETTER CODE	e	LETTER CODE
1.0 MAX	V	1.0	A	1.0	A	0.95	A
		1.5	B	1.5	B	0.65	C
		2.0	C	2.0	C	0.50	D
		2.5	D	2.5	D		
		3.0	E	3.0	E		

TABLE 2: TOLERANCE OF FORM AND POSITION

PITCH (MM) / SYMBOL	0.95	0.65	0.50
aaa	0.10	0.10	0.10
bbb	0.10	0.10	0.10
ccc	0.10	0.10	0.10
ddd	0.05	0.05	0.05
NOTES	1,2		
REF			
ISSUE			



FOR REVISION UPDATE PLEASE REFER TO HISTORY OF CHANGES.

 **Carsem** Your Technology Partner

REV A	DWG NO: - MLPM-CPOD-0004		FILE:- MLPM-CPOD-0004-RevA
	APP'D -		MLP MICRO
	CHECKED CC YIP		PACKAGE OUTLINE
	DESIGNED -		ISOLATED EXPOSED PAD
	DRAWN KC LAU		PAGE : 3 of 7

TABLE 3: COMMON HEIGHT DIMENSION

V-PROFILE HEIGHT

DIM SYMBOL	MIN	NOM	MAX
A	0.80	0.90	1.00
A1	0	0.025	0.05
A2	0.65	0.70	0.75
A3	0.15	0.20	0.25
θ	0°	10°	12°
NOTES	1,2		
REF			
ISSUE			

TABLE 4: COMMON TERMINAL DIMENSIONS

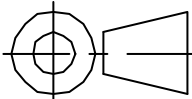
DIM PITCH	b			R1	L2	K
	MIN	NOM	MAX	REF	MAX	MIN
0.65	0.24	0.26	0.34	0.075	0.125	0.20
NOTES	5,12					
REF						
ISSUE						

FOR REVISION UPDATE PLEASE REFER TO HISTORY OF CHANGES.

 **Carsem** Your Technology Partner

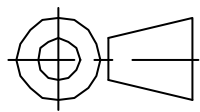
REV A	DWG NO: - MLPM-CPOD-0004			FILE:- MLPM-CPOD-0004-RevA
	APP'D	-		MLP MICRO
	CHECKED	CC YIP		PACKAGE OUTLINE
	DESIGNED	-		ISOLATED EXPOSED PAD
	DRAWN	KC LAU		PAGE : 4 of 7

9 SUMMARY TABLE 5

BODY SIZE (mm)	LEAD PITCH (mm)	LEAD COUNT	VERY THIN PROFILE
3.00 X 2.00	0.65	8	VECC-1

FOR REVISION UPDATE PLEASE REFER TO HISTORY OF CHANGES.

 **Carsem** Your Technology Partner

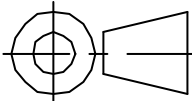
REV A	DWG NO: - MLPM-CPOD-0004			FILE:- MLPM-CPOD-0004-RevA
	APP'D	-		MLP MICRO
	CHECKED	CC YIP		PACKAGE OUTLINE
	DESIGNED	-		ISOLATED EXPOSED PAD
	DRAWN	KC LAU		PAGE 1 5 of 7

## SUMMARY TABLE 5 0.65mm PITCH VARIATION

SYMBOL										NOTE
D BSC	3.00									
D2 MIN	1.50									
D2 NOM	1.60									
D2 MAX	1.70									
D4 MIN	0.91									
D4 NOM	1.01									
D4 MAX	1.11									
E BSC	2.00									
E2 MIN	0.43									
E2 NOM	0.53									
E2 MAX	0.63									
E4 MIN	0.16									
E4 NOM	0.26									
E4 MAX	0.36									
L MIN	0.20									
L NOM	0.29									
L MAX	0.45									
L1 MIN	0.20									
L1 NOM	0.29									
L1 MAX	0.45									
N	8									3
ND	4									6
R REF	0.075									
R2 REF	0.075									
VARV	VECC-1									
NOTE	1,2,9									
REF										
ISSUE										

FOR REVISION UPDATE PLEASE REFER TO HISTORY OF CHANGES.

 **Carsem** Your Technology Partner

REV  
A

DWG NO: - MLPM-CPOD-0004

APP'D	-
CHECKED	CC YIP
DESIGNED	-
DRAWN	KC LAU

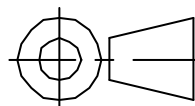

FILE:- MLPM-CPOD-0004-RevA

MLP MICRO  
PACKAGE OUTLINE  
ISOLATED EXPOSED PAD

PAGE 16 of 7

## Note:

1. Dimensioning and tolerancing conform to ASME Y14.5M-1994.
2. All dimensions are in millimeters . All angles are in degrees.
3. N is the total number of terminals.

4. The terminal #1 identifier and terminal numbering convention shall conform to JESD 95-1 SPP-012. Details of terminal #1 identifier are optional , but must be located within the zone indicated. The terminal #1 identifier may be a molded, marked, or metalized features.

5. Dimensions b apply to metalized terminal and is measured between 0.15 and 0.20mm from terminal tip.

6. ND refer to the maximum number of terminals on D side.

7. Depopulation of terminals is allowed and will be called out on the individual variations.

8. Variation VECC is shown for illustration only.

9. For a complete set of dimensions for each variation, see the individual variation and the common dimensions and tolerances on page 4 & 5.

10. Coplanarity applies to the exposed heat sink slug as well as the terminals.

11. Profile tolerance (aaa) will be applicable only to the plastic body, and not to the metalized features (such as the terminal tips and tie bars.) Metalized features may protrude a maximum of L2 from the plastic body profile.

12. Corner will be sharp unless otherwise specified with radius dimensions.

FOR REVISION UPDATE PLEASE REFER TO HISTORY OF CHANGES.



**Carsem** Your Technology Partner

REV  
A

DWG NO: - MLPM-CPOD-0004

APP'D -

CHECKED CC YIP

DESIGNED -

DRAWN KC LAU

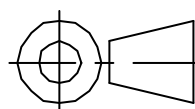

FILE:- MLPM-CPOD-0004-RevA

MLP MICRO  
PACKAGE OUTLINE  
ISOLATED EXPOSED PAD

PAGE : 7 of 7