

TOP VIEW

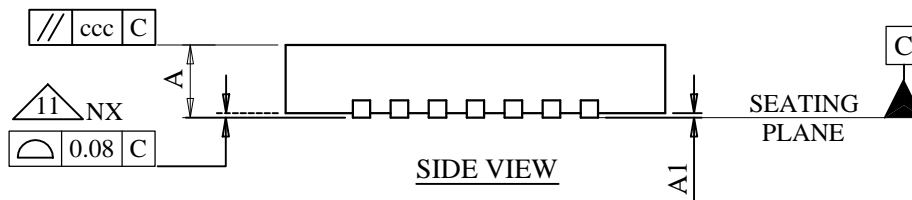

SIDE VIEW

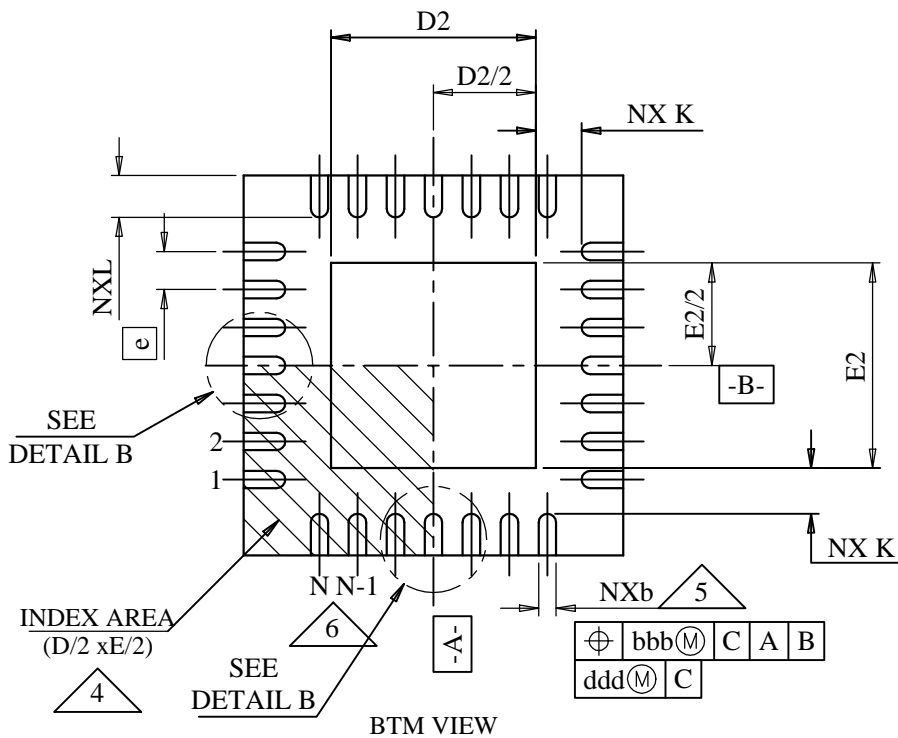

BTM VIEW

FIGURE 1



FOR REVISION UPDATE PLEASE REFER TO HISTORY OF CHANGES.

 **Carsem** Your Technology Partner

AE

DWG NO: PKGML00001

APP'D

CHECKED

DRAWN

DATE

2007-JUN-23

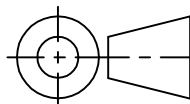

DWG TITLE:

MLP QUAD FAMILY
PACKAGE OUTLINE

Page 1 of 15

BOTTOM VIEW WITH TYPE A ID

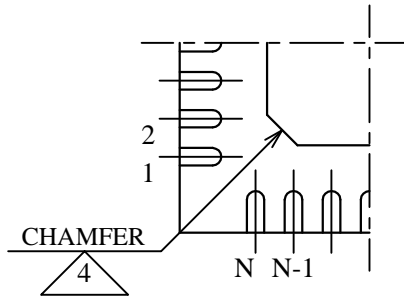

BOTTOM VIEW WITH TYPE B ID

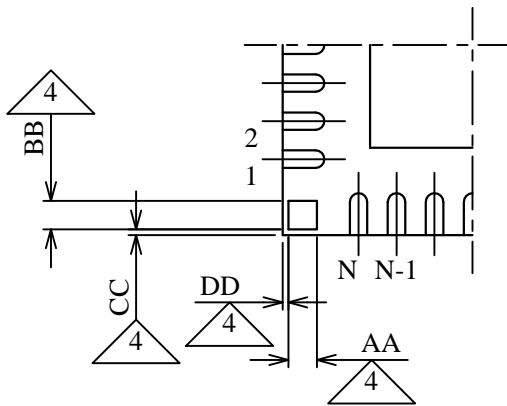

BOTTOM VIEW WITH TYPE C ID

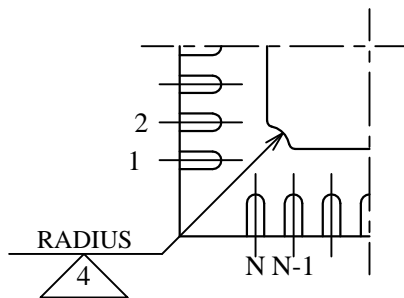

FOR REVISION UPDATE PLEASE REFER TO HISTORY OF CHANGES.



Carsem *Your Technology Partner*

AE

DWG NO: PKGML00001

APP'D

CHECKED

DRAWN

DATE

2007-JUN-23

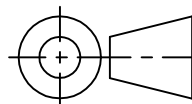

DWG TITLE:

MLP QUAD FAMILY
PACKAGE OUTLINE

Page 2 of 15

VARIATION DESIGNATORS

FIRST DIGIT CODE		SECOND DIGIT CODE		THIRD DIGIT CODE		FOURTH DIGIT CODE	
OVERALL HEIGHT		BODY LENGTH		BODY WIDTH		TERMINAL PITCH	
A	LETTER CODE	D	LETTER CODE	E	LETTER CODE	e	LETTER CODE
1.00 max	V	1.0	A	1.0	A	1.00	A
0.80 max	W	1.5	B	1.5	B	0.80	B
---	---	2.0	C	2.0	C	0.65	C
---	---	2.5	D	2.5	D	0.50	D
---	---	3.0	E	3.0	E	0.40	E
---	---	3.5	F	3.5	F	---	---
---	---	4.0	G	4.0	G	---	---
---	---	5.0	H	5.0	H	---	---
---	---	6.0	J	6.0	J	---	---
---	---	7.0	K	7.0	K	---	---
---	---	8.0	L	8.0	L	---	---
---	---	9.0	M	9.0	M	---	---
---	---	10.0	N	10.0	N	---	---
---	---	11.0	P	11.0	P	---	---
---	---	12.0	R	12.0	R	---	---
---	---	4.5	S	4.5	S	---	---
---	---	5.5	T	5.5	T	---	---
---	---	6.5	U	6.5	U	---	---

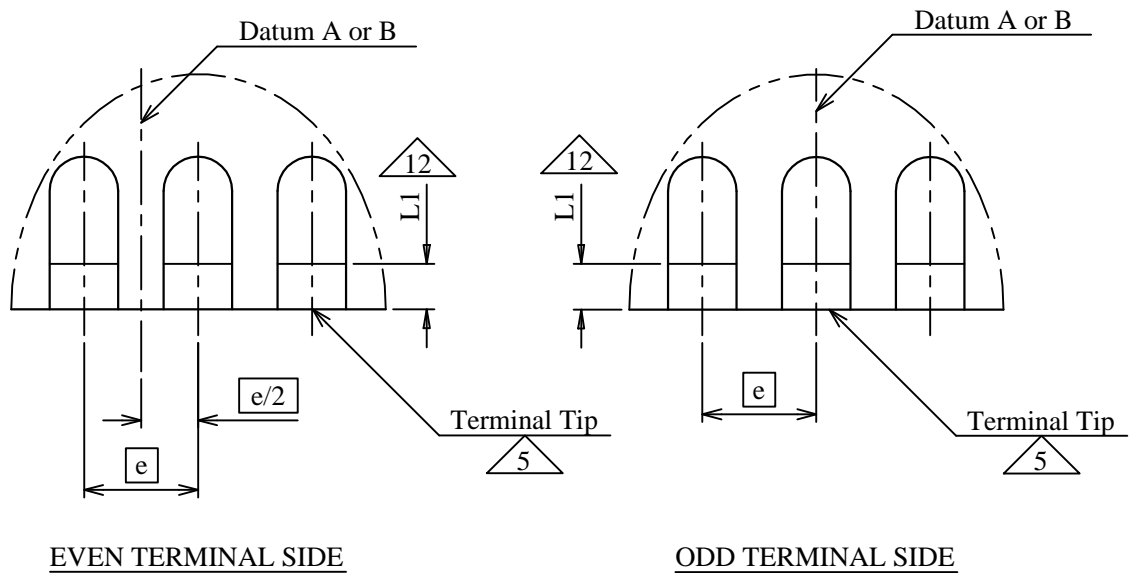

DETAIL B

FOR REVISION UPDATE PLEASE REFER TO HISTORY OF CHANGES.

 **Carsem** *Your Technology Partner*

AE

DWG NO: PKGML00001

APP'D

CHECKED

DRAWN

DATE

2007-JUN-23

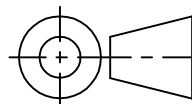

DWG TITLE:

MLP QUAD FAMILY
PACKAGE OUTLINE

Page 3 of 15

COMMON DIMENSION						
TOLERANCE OF FORM AND POSITION						
aaa	0.10					
bbb	0.10					
ccc	0.10					
ddd	0.05					
NOTES	1,2					
REF	11-534					
ISSUE	A					

COMMON DIMENSION						
SYMBOL	V : very thin			W : very very thin		
	MIN	NOM	MAX	MIN	NOM	MAX
A	0.80	0.90	1.00	0.70	0.75	0.80
A1	0.00	0.02	0.05	0.00	0.02	0.05
L1	0.03	---	0.15	0.03	---	0.15
K	0.20	---	---	0.20	---	---
NOTES	1,2					
REF	11-640					
ISSUE	F					

COMMON DIMENSION						
PITCH (e)	LEAD WIDTH [b]					
	MIN	NOM	MAX			
1.00	0.30	0.40	0.45			
0.80	0.25	0.30	0.35			
0.65	0.25	0.30	0.35			
0.50	0.18	0.25	0.30			
0.40	0.15	0.20	0.25			
NOTES	5,14	5,14	5,14			
REF	11-534	11-534	11-534			
ISSUE	A	A	A			

SPECIFIC DIMENSION VARIATION					
VARIATION		LEAD WIDTH [b]			PITCH [e]
		NOM	MAX	MIN	
VEED-5NJ1	WEED-5NJ1	0.15	0.20	0.25	0.50
VLLC-2NJ2	WLLC-2NJ2	0.18	0.25	0.30	0.65

FOR REVISION UPDATE PLEASE REFER TO HISTORY OF CHANGES.

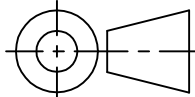

AE	DWG NO: PKGML00001			DWG TITLE:
	APP'D			MLP QUAD FAMILY PACKAGE OUTLINE
	CHECKED			
	DRAWN			
DATE	2007-JUN-23		Page 4 of 15	

Summary Table									
Lead Pitch	Lead Count	Body Size	Very thin FQFP-N	Very very thin FQFP-N	Type A iD	Type B iD			
					Type C iD	AA	BB	CC	DD
0.50	12	3X3	VEED-1	WEED-1	---	0.435	0.435	0.181	0.181
0.50	12	3X3	VEED-1.1	WEED-1.1	R0.20	---	---	---	---
0.50	16	3X3	VEED-2	WEED-2	---	0.235	0.235	0.181	0.181
0.50	12	3X3	VEED-5	WEED-5	---	0.435	0.435	0.18	0.18
0.50	12	3X3	VEED-5.1	WEED-5.1	R0.20	---	---	---	---
0.50	16	3X3	VEED-6.0	WEED-6.0	---	0.235	0.235	0.181	0.181
0.50	16	3X3	VEED-6.1	WEED-6.1	R0.20	---	---	---	---
0.50	20	4X4	VGGD-1	WGGD-1	---	0.435	0.435	0.181	0.181
0.50	24	4X4	VGGD-2	WGGD-2	---	0.235	0.235	0.181	0.181
0.50	24	4X4	VGGD-8	WGGD-8	---	0.235	0.235	0.181	0.181
0.50	24	4X4	VGGD-8.1	WGGD-8.1	R0.20	---	---	---	---
0.50	16	4X4	VGGD-10	WGGD-10	C'0.225	---	---	---	---
0.50	24	5X4	VHGD	WHGD	---	0.435	0.435	0.181	0.181
0.50	28	5X5	VHHD-1	WHHD-1	---	0.435	0.435	0.181	0.181
0.50	28	5X5	VHHD-1.1	WHHD-1.1	R0.30	---	---	---	---
0.50	32	5X5	VHHD-2	WHHD-2	---	0.235	0.235	0.181	0.181
0.50	32	5X5	VHHD-5.0	WHHD-5.0	---	0.235	0.235	0.181	0.181
0.50	32	5X5	VHHD-5.1	WHHD-5.1	R0.30	---	---	---	---
0.50	38	5X7	VHKD	WHKD	---	0.357	0.232	0.181	0.181
0.50	32	6X5	VJHD	WJHD	C'0.225	---	---	---	---
0.50	36	6X6	VJJD-1	WJJD-1	---	0.435	0.435	0.181	0.181
0.50	40	6X6	VJJD-2	WJJD-2	---	0.235	0.235	0.181	0.181
0.50	40	6X6	VJJD-2.1	WJJD-2.1	R0.30	---	---	---	---
0.50	36	6X6	VJJD-8	WJJD-8	C'0.225	---	---	---	---
0.50	38	7X5	VKHD	WKHD	---	0.232	0.357	0.18	0.18
0.50	44	7X7	VKKD-1	WKKD-1	---	0.435	0.435	0.181	0.181
0.50	48	7X7	VKKD-2	WKKD-2	C'0.350	---	---	---	---
0.50	56	8X8	VLLD-2.0	WLLD-2.0	---	0.235	0.235	0.181	0.181
0.50	56	8X8	VLLD-2.1	WLLD-2.1	R0.30	---	---	---	---
0.50	64	9X9	VWWD-4	WMMD-4	R0.45	---	---	---	---

FOR REVISION UPDATE PLEASE REFER TO HISTORY OF CHANGES.



Carsem *Your Technology Partner*

AE

DWG NO: PKGML00001

APP'D

CHECKED

DRAWN

DATE

2007-JUN-23

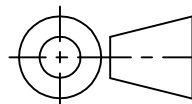

DWG TITLE:

MLP QUAD FAMILY
PACKAGE OUTLINE

Page 5 of 15

Summary Table

Lead Pitch	Lead Count	Body Size	Very thin FQFP-N	Very very thin FQFP-N	Type A iD	Type B iD			
					Type C iD	AA	BB	CC	DD
0.50	16	3X3	VEED-4NJ1	WEED-4NJ1	C'0.225	---	---	---	---
0.50	16	3X3	VEED-4NJ2	WEED-4NJ2	R0.20	---	---	---	---
0.50	16	3X3	VEED-4NJ3	WEED-4NJ3	R0.20	---	---	---	---
0.50	12	3X3	VEED-5NJ1	WEED-5NJ1	R0.20	---	---	---	---
0.50	16	3X3	VEED-6NJ1	WEED-6NJ1	R0.20	---	---	---	---
0.50	16	3X3	VEED-6NJ2	WEED-6NJ2	R0.20	---	---	---	---
0.50	20	3X4	VEGD-NJ1	WEGD-NJ1	R0.20	---	---	---	---
0.50	20	4x4	VGGD-1NJ1	WGGD-1NJ1	R0.20	---	---	---	---
0.50	24	4X4	---	WGGD-1NJ2	R0.20	---	---	---	---
0.50	20	4X4	VGGD-5NJ1	WGGD-5NJ1	C'0.225	---	---	---	---
0.50	24	4X4	VGGD-6NJ1	WGGD-6NJ1	C'0.225	---	---	---	---
0.50	24	4X4	VGGD-6NJ2	WGGD-6NJ2	R0.20	---	---	---	---
0.50	24	4X4	VGGD-6NJ3	WGGD-6NJ3	R0.20	---	---	---	---
0.50	20	4x5	VGHD-1NJ1	WGHD-1NJ1	R0.30	---	---	---	---
0.50	24	4X5	VGHD-1NJ2	WGHD-1NJ2	C'0.225	---	---	---	---
0.50	28	4X5	VGHD-3NJ1	WGHD-3NJ1	R0.30	---	---	---	---
0.50	32	4x6	VGJD-NJ1	WGJD-NJ1	R0.30	---	---	---	---
0.50	28	5X5	VHHD-1NJ1	---	R0.30	---	---	---	---
0.50	28	5x5	VHHD-1NJ2	WHHD-1NJ2	C0.350	---	---	---	---
0.50	32	5x5	VHHD-5NJ1	WHHD-5NJ1	R0.30	---	---	---	---
0.50	32	5x6	VHJD-NJ1	WHJD-NJ1	R0.30	---	---	---	---
0.50	40	5X7	VHKD-NJ1	WHKD-NJ1	R0.30	---	---	---	---
0.50	40	5X7	VHKD-NJ2	WHKD-NJ2	R0.30	---	---	---	---
0.50	38	5X7	VHKD-1NJ1	WHKD-1NJ1	R0.30	---	---	---	---
0.50	40	6X6	VJJD-1NJ1	WJJD-1NJ1	R0.30	---	---	---	---
0.50	36	6X6	VJJD-6NJ1	WJJD-6NJ1	R0.30	---	---	---	---
0.50	36	6X6	VJJD-8NJ1	WJJD-8NJ1	C'0.225	---	---	---	---
0.50	48	7X7	VKKD-NJ1	WKKD-NJ1	R0.30	---	---	---	---
0.50	48	7X7	VKKD-4NJ1	WKKD-4NJ1	R0.30	---	---	---	---
0.50	56	8X8	VLLD-2NJ1	WLLD-2NJ1	R0.30	---	---	---	---
0.50	56	8X8	VLLD-6NJ1	WLLD-6NJ1	C'0.350	---	---	---	---
0.50	64	9X9	VMMD-3NJ1	WMMD-3NJ1	---	0.235	0.235	0.181	0.181
0.50	64	9X9	VMMD-3NJ2	WMMD-3NJ2	R0.45	---	---	---	---
0.50	64	9X9	VMMD-3NJ3	WMMD-3NJ3	R0.45	---	---	---	---
0.50	60	9X9	VMMD-NJ1	WMMD-NJ1	R0.45	---	---	---	---
0.50	72	10x10	VNND-2NJ1	---	R0.45	---	---	---	---
0.50	72	10X10	VNND-3NJ1	WNND-3NJ1	R0.45	---	---	---	---
0.50	72	10X10	VNND-3NJ2	WNND-3NJ2	R0.45	---	---	---	---
0.50	56	11x5	VPHD-NJ1	WPHD-NJ1	R0.45	---	---	---	---
0.50	80	11x11	VPPD-NJ1	WPPD-NJ1	R0.45	---	---	---	---
0.50	88	12X12	VRRD-NJ1	WRRD-NJ1	R0.45	---	---	---	---
0.50	88	12X12	VRRD-NJ2	WRRD-NJ2	R0.45	---	---	---	---

FOR REVISION UPDATE PLEASE REFER TO HISTORY OF CHANGES.



Carsem Your Technology Partner

AE

DWG NO: PKGML00001

APP'D

CHECKED

DRAWN

DATE

2007-JUN-23

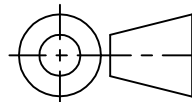

DWG TITLE:

MLP QUAD FAMILY PACKAGE OUTLINE

Page 6 of 15

Summary Table									
Lead Pitch	Lead Count	Body Size	Very thin FQFP-N	Very very thin FQFP-N	Type A iD	Type B iD			
					Type C iD	AA	BB	CC	DD
0.65	8	3X3	VEEC-3	WEEC-3	---	0.434	0.434	0.181	0.181
0.65	16	4X4	VGGC.0	WGGC.0	---	0.344	0.344	0.181	0.181
0.65	16	4X4	VGGC.1	WGGC.1	R0.20	---	---	---	---
0.65	16	4X4	VGGC-3.0	WGGC-3.0	---	0.344	0.344	0.181	0.181
0.65	16	4X4	VGGC-3.1	WGGC-3.1	R0.20	---	---	---	---
0.65	20	5X5	VHHC	WHHC	---	0.519	0.519	0.181	0.181
0.65	28	6X6	VJJC	WJJC	---	0.434	0.434	0.181	0.181
0.65	32	7X7	VKKC.0	WKKC.0	---	0.545	0.545	0.18	0.18
0.65	32	7X7	VKKC.1	WKKC.1	C'0.350	---	---	---	---

Summary Table									
Lead Pitch	Lead Count	Body Size	Very thin FQFP-N	Very very thin FQFP-N	Type A iD	Type B iD			
					Type C iD	AA	BB	CC	DD
0.65	12	4x4	VGGC-NJ1	WGGC-NJ1	C'0.225	---	---	---	---
0.65	16	4x4	VGGC-3NJ1	WGGC-3NJ1	R0.20	---	---	---	---
0.65	18	5x4	VHGC-1NJ1	WHGC-1NJ1	R0.30	---	---	---	---
0.65	28	6X6	VJJC-4NJ1	WJJC-4NJ1	R0.30	---	---	---	---
0.65	32	7x7	VKKC-NJ1	WKKC-NJ1	R0.30	---	---	---	---
0.65	38	7X9	VKMC-NJ1	WKMC-NJ1	R0.45	---	---	---	---
0.65	44	8X8	VLLC-2NJ1	WLLC-2NJ1	R0.30	---	---	---	---
0.65	44	8X8	VLLC-2NJ2	WLLC-2NJ2	R0.30	---	---	---	---
0.65	44	8X8	VLLC-2NJ3	WLLC-2NJ3	R0.30	---	---	---	---
0.65	44	9X9	VMMC-1NJ1	WMMC-1NJ1	C'0.350	---	---	---	---

Summary Table									
Lead Pitch	Lead Count	Body Size	Very thin FQFP-N	Very very thin FQFP-N	Type A iD	Type B iD			
					Type C iD	AA	BB	CC	DD
0.80	12	4X4	VGGB.0	WGGB.0	---	0.434	0.434	0.181	0.181
0.80	12	4X4	VGGB.1	WGGB.1	C'0.225	---	---	---	---
0.80	28	6X6	VJJB.0	WJJB.0	R0.30	---	---	---	---
0.80	28	7X7	VKKB	WKKB	R0.30	---	---	---	---
0.80	28	7X7	VKKB.1	WKKB.1	R0.30	---	---	---	---

Summary Table									
Lead Pitch	Lead Count	Body Size	Very thin FQFP-N	Very very thin FQFP-N	Type A iD	Type B iD			
					Type C iD	AA	BB	CC	DD
0.80	20	5X5	VHHB-NJ1	WHHB-NJ1	R0.30	---	---	---	---

Summary Table									
Lead Pitch	Lead Count	Body Size	Very thin FQFP-N	Very very thin FQFP-N	Type A iD	Type B iD			
					Type C iD	AA	BB	CC	DD
1.00	12	5X5	VHHA-NJ1	WHHA-NJ1	C'0.225	---	---	---	---

FOR REVISION UPDATE PLEASE REFER TO HISTORY OF CHANGES.



Carsem *Your Technology Partner*

AE

DWG NO: PKGML00001

APP'D

CHECKED

DRAWN

DATE

2007-JUN-23

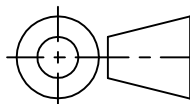

DWG TITLE:

MLP QUAD FAMILY
PACKAGE OUTLINE

Page 7 of 15

		e=1.00 Pitch								
Variation Symbol	VHHA-NJ1									Note
	WHHA-NJ1									
D BSC	5.00									
E BSC	5.00									
D1 BSC	---									
E1 BSC	---									
D2	MIN	3.00								
	NOM	3.15								
	MAX	3.25								
E2	MIN	3.00								
	NOM	3.15								
	MAX	3.25								
L	MIN	0.45								
	NOM	0.55								
	MAX	0.65								
N	12									
ND	3									
NE	3									
NOTES	1,2,10									
REF	---									
ISSUE	---									

		e=0.80 Pitch								
Variation Symbol	VGGB.0	VGGB.1	VHHB-NJ1	VJJB.0	VKKB	VKKB.1				Note
	WGGB.0	WGGB.1	WHHB-NJ1	WJJB.0	WKKB	WKKB.1				
D BSC	4.00	4.00	5.00	6.00	7.00	7.00				
E BSC	4.00	4.00	5.00	6.00	7.00	7.00				
D1 BSC	---	---	---	---	---	---				
E1 BSC	---	---	---	---	---	---				
D2	MIN	2.00	2.00	3.50	3.28	4.95	3.85			
	NOM	2.15	2.15	3.65	3.43	5.10	4.00			
	MAX	2.25	2.25	3.75	3.53	5.20	4.10			
E2	MIN	2.00	2.00	3.50	3.28	4.95	3.85			
	NOM	2.15	2.15	3.65	3.43	5.10	4.00			
	MAX	2.25	2.25	3.75	3.53	5.20	4.10			
L	MIN	0.45	0.45	0.25	0.50	0.50	0.45			
	NOM	0.55	0.55	0.35	0.60	0.60	0.55			
	MAX	0.65	0.65	0.45	0.70	0.70	0.65			
N	12	12	20	20	28	28				
ND	3	3	5	5	7	7				
NE	3	3	5	5	7	7				
NOTES	1,2,10	1,2,10	1,2,10	1,2,10	1,2,10	1,2,10				
REF	---	---	---	---	---	---				
ISSUE	---	---	---	---	---	---				

FOR REVISION UPDATE PLEASE REFER TO HISTORY OF CHANGES.



Carsem *Your Technology Partner*

AE

DWG NO: PKGML00001

APP'D

CHECKED

DRAWN

DATE

2007-JUN-23

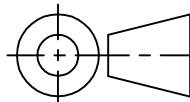

DWG TITLE:

MLP QUAD FAMILY
PACKAGE OUTLINE

Page 8 of 15

e=0.65 Pitch										
Variation Symbol	VEEC-3	VGGC.0	VGGC.1	VGGC-3.0	VGGC-3.1	VHHC	VJJC	VKKC.0	VKKC.1	Note
	WEEC-3	WGGC.0	WGGC.1	WGGC-3.0	WGGC-3.1	WHHC	WJJC	WKKC.0	WKKC.1	
D BSC	3.00	4.00	4.00	4.00	4.00	5.00	6.00	7.00	7.00	
E BSC	3.00	4.00	4.00	4.00	4.00	5.00	6.00	7.00	7.00	
D1 BSC	---	---	---	---	---	---	---	---	---	
E1 BSC	---	---	---	---	---	---	---	---	---	
D2	MIN	1.55	2.00	2.00	2.55	2.55	3.00	3.55	5.00	5.00
	NOM	1.70	2.15	2.15	2.70	2.70	3.15	3.70	5.15	5.15
	MAX	1.80	2.25	2.25	2.80	2.80	3.25	3.80	5.25	5.25
E2	MIN	1.55	2.00	2.00	2.55	2.55	3.00	3.55	5.00	5.00
	NOM	1.70	2.15	2.15	2.70	2.70	3.15	3.70	5.15	5.15
	MAX	1.80	2.25	2.25	2.80	2.80	3.25	3.80	5.25	5.25
L	MIN	0.30	0.45	0.45	0.30	0.30	0.45	0.50	0.45	0.45
	NOM	0.40	0.55	0.55	0.40	0.40	0.55	0.60	0.55	0.55
	MAX	0.50	0.65	0.65	0.50	0.50	0.65	0.70	0.65	0.65
N	8	16	16	16	16	20	28	32	32	
ND	2	4	4	4	4	5	7	8	8	
NE	2	4	4	4	4	5	7	8	8	
NOTES	1,2,10	1,2,10	1,2,10	1,2,10	1,2,10	1,2,10	1,2,10	1,2,10	1,2,10	
REF	11-534	11-534	11-534	11-534	11-534	11-620	11-620	11-534	11-534	
ISSUE	A	A	A	A	A	D	D	A	A	

e=0.65 Pitch										
Variation Symbol	VGGC-NJ1	VGGC-3NJ1	VHGC-1NJ1	VJJC-4NJ1	VKKC-NJ1	VKMC-NJ1	VLLC-2NJ1	VLLC-2NJ2	VLLC-2NJ3	Note
	WGGC-NJ1	WGGC-3NJ1	WHGC-1NJ1	WJJC-4NJ1	WKKC-NJ1	WKMC-NJ1	WLLC-2NJ1	WLLC-2NJ2	WLLC-2NJ3	
D BSC	4.00	4.00	5.00	6.00	7.00	7.00	8.00	8.00	8.00	
E BSC	4.00	4.00	4.00	6.00	7.00	9.00	8.00	8.00	8.00	
D1 BSC	---	---	---	---	---	---	---	---	---	
E1 BSC	---	---	---	---	---	---	---	---	---	
D2	MIN	1.95	2.00*	3.45	4.30	5.00	5.00	6.30*	6.30*	6.50
	NOM	2.10	2.15	3.60	4.45	5.15	5.15	6.45	6.45	6.65
	MAX	2.20	2.25	3.70	4.55	5.25	5.25	6.55	6.55	6.75
E2	MIN	1.95	2.00*	2.45	4.30	5.00	7.00	6.30*	6.30*	6.50
	NOM	2.10	2.15	2.60	4.45	5.15	7.15	6.45	6.45	6.65
	MAX	2.20	2.25	2.70	4.55	5.25	7.25	6.55	6.55	6.75
L	MIN	0.55	0.30	0.30	0.30	0.45	0.45	0.30*	0.30*	0.30*
	NOM	0.65	0.40	0.40	0.40	0.55	0.55	0.40	0.40	0.40
	MAX	0.75	0.50	0.50	0.50	0.65	0.65	0.50	0.50	0.50
N	12	16	18	28	32	38	44	44	44	
ND	4	4	5	7	8	8	11	11	11	
NE	4	4	4	7	8	11	11	11	11	
NOTES	1,2,10	1,2,10	1,2,10	1,2,10	1,2,10	1,2,10	1,2,10	1,2,10	1,2,10	
REF	n/a	n/a	n/a	n/a	n/a	n/a	n/a	n/a	n/a	
ISSUE	n/a	n/a	n/a	n/a	n/a	n/a	n/a	n/a	n/a	

FOR REVISION UPDATE PLEASE REFER TO HISTORY OF CHANGES.



Carsem Your Technology Partner

AE

DWG NO: PKGML00001

APP'D

CHECKED

DRAWN

DATE

2007-JUN-23

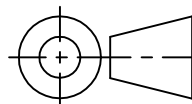

DWG TITLE:

MLP QUAD FAMILY PACKAGE OUTLINE

Page 9 of 15

e=0.65 Pitch										
Variation Symbol	VMMC-1NJ1									Note
	WMMC-1NJ1									
D BSC	9.00									
E BSC	9.00									
D1 BSC	---									
E1 BSC	---									
D2	MIN	7.25*								
	NOM	7.40								
	MAX	7.50								
E2	MIN	7.25*								
	NOM	7.40								
	MAX	7.50								
L	MIN	0.30								
	NOM	0.40								
	MAX	0.50								
N	44									
ND	11									
NE	11									
NOTES	1,2,10									
REF	n/a									
ISSUE	n/a									

e=0.50 Pitch										
Variation Symbol	VEED-1	VEED-1.1	VEED-2	VEED-5	VEED-5.1	VEED-6.0	VEED-6.1	VGGD-1	VGGD-2	Note
	WEED-1	WEED-1.1	WEED-2	WEED-5	WEED-5.1	WEED-6.0	WEED-6.1	WGGD-1	WGGD-2	
D BSC	3.00	3.00	3.00	3.00	3.00	3.00	3.00	4.00	4.00	
E BSC	3.00	3.00	3.00	3.00	3.00	3.00	3.00	4.00	4.00	
D1 BSC	---	---	---	---	---	---	---	---	---	
E1 BSC	---	---	---	---	---	---	---	---	---	
D2	MIN	1.00	1.00	1.00	1.30	1.30	1.30	1.30	2.00	2.00
	NOM	1.15	1.15	1.15	1.45	1.45	1.45	1.45	2.15	2.15
	MAX	1.25	1.25	1.25	1.55	1.55	1.55	1.55	2.25	2.25
E2	MIN	1.00	1.00	1.00	1.30	1.30	1.30	1.30	2.00	2.00
	NOM	1.15	1.15	1.15	1.45	1.45	1.45	1.45	2.15	2.15
	MAX	1.25	1.25	1.25	1.55	1.55	1.55	1.55	2.25	2.25
L	MIN	0.45	0.45	0.30	0.30	0.30	0.30	0.30	0.45	0.30
	NOM	0.55	0.55	0.40	0.40	0.40	0.40	0.40	0.55	0.40
	MAX	0.65	0.65	0.50	0.50	0.50	0.50	0.50	0.65	0.50
N	12	12	16	12	12	16	16	20	24	
ND	3	3	4	3	3	4	4	5	6	
NE	3	3	4	3	3	4	4	5	6	
NOTES	1,2,10	1,2,10	1,2,10	1,2,10	1,2,10	1,2,10	1,2,10	1,2,10	1,2,10	
REF	---	---	---	---	---	---	---	---	---	
ISSUE	---	---	---	---	---	---	---	---	---	

FOR REVISION UPDATE PLEASE REFER TO HISTORY OF CHANGES.



AE

DWG NO: PKGML00001

APP'D

CHECKED

DRAWN

DATE

2007-JUN-23

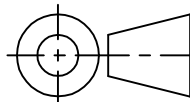

DWG TITLE:

MLP QUAD FAMILY
PACKAGE OUTLINE

Page 10 of 15

e=0.50 Pitch										
Variation Symbol	VGGD-8	VGGD-8.1	VGGD-10	VHGD	VHHD-1	VHHD-1.1	VHHD-2	VHHD-5.0	VHHD-5.1	Note
	WGGD-8	WGGD-8.1	WGGD-10	WHGD	WHHD-1	WHHD-1.1	WHHD-2	WHHD-5.0	WHHD-5.1	
D BSC	4.00	4.00	4.00	5.00	5.00	5.00	5.00	5.00	5.00	
E BSC	4.00	4.00	4.00	4.00	5.00	5.00	5.00	5.00	5.00	
D1 BSC	---	---	---	---	---	---	---	---	---	
E1 BSC	---	---	---	---	---	---	---	---	---	
D2	MIN	2.30	2.30	2.30	3.00	3.00	3.00	3.00	3.30	3.30
	NOM	2.45	2.45	2.45	3.15	3.15	3.15	3.15	3.45	3.45
	MAX	2.55	2.55	2.55	3.25	3.25	3.25	3.25	3.55	3.55
E2	MIN	2.30	2.30	2.30	2.00	3.00	3.00	3.00	3.30	3.30
	NOM	2.45	2.45	2.45	2.15	3.15	3.15	3.15	3.45	3.45
	MAX	2.55	2.55	2.55	2.25	3.25	3.25	3.25	3.55	3.55
L	MIN	0.30	0.30	0.30	0.45	0.45	0.45	0.30	0.30	0.30
	NOM	0.40	0.40	0.40	0.55	0.55	0.55	0.40	0.40	0.40
	MAX	0.50	0.50	0.50	0.75	0.65	0.65	0.50	0.50	0.50
N	24	24	16	24	28	28	32	32	32	
ND	6	6	4	7	7	7	8	8	8	
NE	6	6	4	5	7	7	8	8	8	
NOTES	1,2,10	1,2,10	1,2,10	1,2,10	1,2,10	1,2,10	1,2,10	1,2,10	1,2,10	
REF	---	---	---	---	---	---	---	---	---	
ISSUE	---	---	---	---	---	---	---	---	---	

e=0.50 Pitch										
Variation Symbol	VHKD	VJHD	VJJD-1	VJJD-2	VJJD-2.1	VKHD	VKKD-1	VKKD-2	VLLD-2.0	Note
	WHKD	WJHD	WJJD-1	WJJD-2	WJJD-2.1	WKHD	WKKD-1	WKKD-2	WLLD-2.0	
D BSC	5.00	6.00	6.00	6.00	6.00	7.00	7.00	7.00	8.00	
E BSC	7.00	5.00	6.00	6.00	6.00	5.00	7.00	7.00	8.00	
D1 BSC	---	---	---	---	---	---	---	---	---	
E1 BSC	---	---	---	---	---	---	---	---	---	
D2	MIN	3.00	4.00	4.00	4.00	4.00	5.00	5.00	5.00	6.00
	NOM	3.15	4.15	4.15	4.15	4.15	5.15	5.15	5.15	6.15
	MAX	3.25	4.25	4.25	4.25	4.25	5.25	5.25	5.25	6.25
E2	MIN	5.00	3.00	4.00	4.00	4.00	3.00	5.00	5.00	6.00
	NOM	5.15	3.15	4.15	4.15	4.15	3.15	5.15	5.15	6.15
	MAX	5.25	3.25	4.25	4.25	4.25	3.25	5.25	5.25	6.25
L	MIN	0.30	0.45	0.45	0.30	0.30	0.30	0.45	0.30	0.30
	NOM	0.40	0.55	0.55	0.40	0.40	0.40	0.55	0.40	0.40
	MAX	0.50	0.65	0.65	0.50	0.50	0.50	0.65	0.50	0.50
N	38	32	36	40	40	38	44	48	56	
ND	7	9	9	10	10	12	11	12	14	
NE	12	7	9	10	10	7	11	12	14	
NOTES	1,2,10	1,2,10	1,2,10	1,2,10	1,2,10	1,2,10	1,2,10	1,2,10	1,2,10	
REF	---	---	---	---	---	---	---	---	---	
ISSUE	---	---	---	---	---	---	---	---	---	

FOR REVISION UPDATE PLEASE REFER TO HISTORY OF CHANGES.



AE

DWG NO: PKGML00001

APP'D

CHECKED

DRAWN

DATE

2007-JUN-23

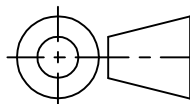

DWG TITLE:

MLP QUAD FAMILY
PACKAGE OUTLINE

Page 11 of 15

e= 0.50 Pitch										
Variation Symbol	VLLD-2.1	VMMD-4	VEED-4NJ1	VEED-4NJ2	VEED-4NJ3	VEED-5NJ1	VEED-6NJ1	VEED-6NJ2	VEED-6NJ2	Note
	WLLD-2.1	WMMD-4	WEED-4NJ1	WEED-4NJ2	WEED-4NJ3	WEED-5NJ1	WEED-6NJ1	WEED-6NJ2	WEED-6NJ2	
D BSC	8.00	9.00	3.00	3.00	3.00	3.00	3.00	3.00	3.00	
E BSC	8.00	9.00	3.00	3.00	3.00	3.00	3.00	3.00	3.00	
D1 BSC	---	---	---	---	---	---	---	---	---	
E1 BSC	---	---	---	---	---	---	---	---	---	
D2	MIN	6.00	6.20	1.55	1.55	1.55	1.40	1.40	1.40	
	NOM	6.15	6.35	1.70	1.70	1.70	1.55	1.55	1.55	
	MAX	6.25	6.45	1.80	1.80	1.80	1.65*	1.65*	1.65*	
E2	MIN	6.00	6.20	1.55	1.55	1.55	1.40	1.40	1.40	
	NOM	6.15	6.35	1.70	1.70	1.70	1.55	1.55	1.55	
	MAX	6.25	6.45	1.80	1.80	1.80	1.65*	1.65*	1.65*	
L	MIN	0.30	0.30	0.30*	0.20*	0.30*	0.30	0.30	0.30	
	NOM	0.40	0.40	0.40	0.30	0.40	0.40	0.40	0.40	
	MAX	0.50	0.50	0.50	0.40	0.50*	0.50	0.50	0.50	
N	56	64	16	16	16	12	16	16	16	
ND	14	16	4	4	4	3	4	4	4	
NE	14	16	4	4	4	3	4	4	4	
NOTES	1,2,10	1,2,10	1,2,10	1,2,10	1,2,10	1,2,10	1,2,10	1,2,10	1,2,10	
REF	---	---	---	---	---	---	---	---	---	
ISSUE	---	---	---	---	---	---	---	---	---	

e= 0.50 Pitch										
Variation Symbol	VEGD-NJ1	VGGD-1NJ1	---	VGGD-5NJ1	VGGD-6NJ1	VGGD-6NJ2	VGGD-6NJ3	VGHD-1NJ1	VGHD-1NJ2	Note
	WEGD-NJ1	WGGD-1NJ1	WGGD-1NJ2	WGGD-5NJ1	WGGD-6NJ1	WGGD-6NJ2	WGGD-6NJ3	WGHD-1NJ1	WGHD-1NJ2	
D BSC	3.00	4.00	4.00	4.00	4.00	4.00	4.00	4.00	4.00	
E BSC	4.00	4.00	4.00	4.00	4.00	4.00	4.00	5.00	5.00	
D1 BSC	---	---	---	---	---	---	---	---	---	
E1 BSC	---	---	---	---	---	---	---	---	---	
D2	MIN	1.50	2.30	1.45	2.55	2.55	2.55	2.55	2.50	
	NOM	1.65	2.45	1.60	2.70	2.70	2.70	2.70	2.65	
	MAX	1.75	2.55*	1.70	2.80	2.80	2.80	2.80	2.75	
E2	MIN	2.50	2.30	1.45	2.55	2.55	2.55	2.55	3.50	
	NOM	2.65	2.45	1.60	2.70	2.70	2.70	2.70	3.65	
	MAX	2.75	2.55*	1.70	2.80	2.80	2.80	2.80	3.75	
L	MIN	0.30	0.30*	0.30*	0.30*	0.30*	0.25*	0.30*	0.30*	
	NOM	0.40	0.40	0.40	0.40	0.40	0.35	0.40	0.40	
	MAX	0.50	0.50	0.50	0.50*	0.50*	0.45	0.50*	0.50	
N	20	20	24	20	24	24	24	20	24	
ND	4	5	6	5	6	6	6	4	5	
NE	5	5	6	5	6	6	6	6	7	
NOTES	1,2,10	1,2,10	1,2,10	1,2,10	1,2,10	1,2,10	1,2,10	1,2,10	1,2,10	
REF	---	---	---	---	---	---	---	---	---	
ISSUE	---	---	---	---	---	---	---	---	---	

FOR REVISION UPDATE PLEASE REFER TO HISTORY OF CHANGES.



AE

DWG NO: PKGML00001

APP'D

CHECKED

DRAWN

DATE

2007-JUN-23

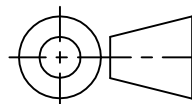

DWG TITLE:

MLP QUAD FAMILY
PACKAGE OUTLINE

Page 12 of 15

e= 0.50 Pitch										
Variation Symbol	VGHD-3NJ1	VGJD-NJ1	VHHD-1NJ1	VHHD-1NJ2	VHHD-5NJ1	VHJD-NJ1	VHKD-NJ1	VHKD-NJ2	VHKD-1NJ1	Note
	WGHD-3NJ1	WGJD-NJ1	-	WHHD-1NJ2	WHHD-5NJ1	WHJD-NJ1	WHKD-NJ1	WHKD-NJ2	WHKD-1NJ1	
D BSC	4.00	4.00	5.00	5.00	5.00	5.00	5.00	5.00	5.00	
E BSC	5.00	6.00	5.00	5.00	5.00	6.00	7.00	7.00	7.00	
D1 BSC	---	---	---	---	---	---	---	---	---	
E1 BSC	---	---	---	---	---	---	---	---	---	
D2	MIN	2.50	2.45	3.00	3.10	3.15*	3.35	3.15	3.30	3.35*
	NOM	2.65	2.60	3.15	3.25	3.30	3.50	3.30	3.45	3.50
	MAX	2.75	2.70	3.25	3.35*	3.40	3.60	3.40	3.55	3.60
E2	MIN	3.50	4.45	3.00	3.15	3.15*	4.35	5.15	5.30	5.35*
	NOM	3.65	4.60	3.15	3.25	3.30	4.50	5.30	5.45	5.50
	MAX	3.75	4.70	3.25	3.35*	3.40	4.60	5.40	5.55	5.60
L	MIN	0.30*	0.25	0.45*	0.45	0.30	0.30	0.30	0.30	0.30*
	NOM	0.40	0.35	0.55	0.55	0.40	0.40*	0.40	0.40	0.40
	MAX	0.50	0.45	0.65	0.65	0.50	0.50*	0.50	0.50	0.50
N	28	32	28	28	32	32	40	40	38	
ND	6	6	7	7	8	7	8	8	7	
NE	8	10	7	7	8	9	12	12	12	
NOTES	1,2,10	1,2,10	1,2,10	1,2,10	1,2,10	1,2,10	1,2,10	1,2,10	1,2,10	
REF	---	---	---	---	---	---	---	---	---	
ISSUE	---	---	---	---	---	---	---	---	---	

e= 0.50 Pitch										
Variation Symbol	VJJD-1NJ1	VJJD-6NJ1	VJJD-8NJ1	VKGD-NJ1	VKGD-4NJ1	VLLD-2NJ1	VLLD-6NJ1	VMMD-3NJ1	VMMD-3NJ2	Note
	WJJD-1NJ1	WJJD-6NJ1	WJJD-8NJ1	WKGD-NJ1	WKGD-4NJ1	WLLD-2NJ1	WLLD-6NJ1	WMMD-3NJ1	WMMD-3NJ2	
D BSC	6.00	6.00	6.00	7.00	7.00	8.00	8.00	9.00	9.00	
E BSC	6.00	6.00	6.00	7.00	7.00	8.00	8.00	9.00	9.00	
D1 BSC	---	---	---	---	---	---	---	---	---	
E1 BSC	---	---	---	---	---	---	---	---	---	
D2	MIN	2.75	3.80	4.30	4.15	5.40*	4.25	4.35	7.00	7.00
	NOM	2.90	3.95	4.45	4.30	5.55	4.40	4.50	7.15	7.15
	MAX	3.00	4.05	4.55	4.40	5.65	4.50	4.60	7.25	7.25
E2	MIN	2.75	3.80	4.30	4.15	5.40*	4.95	5.05	7.00	7.00
	NOM	2.90	3.95	4.45	4.30	5.55	5.10	5.20	7.15	7.15
	MAX	3.00	4.05	4.55	4.40	5.65	5.20	5.30	7.25	7.25
L	MIN	0.30*	0.45	0.30	0.30	0.30*	0.30	0.30*	0.30*	0.30*
	NOM	0.40	0.55	0.40	0.40	0.40	0.40	0.40	0.40	0.40
	MAX	0.50	0.65*	0.50	0.50	0.50	0.50	0.50	0.50	0.50
N	40	36	36	48	48	56	56	64	64	
ND	10	9	9	12	12	14	14	16	16	
NE	10	9	9	12	12	14	14	16	16	
NOTES	1,2,10	1,2,10	1,2,10	1,2,10	1,2,10	1,2,10	1,2,10	1,2,10	1,2,10	
REF	---	---	---	---	---	---	---	---	---	
ISSUE	---	---	---	---	---	---	---	---	---	

FOR REVISION UPDATE PLEASE REFER TO HISTORY OF CHANGES.



Carsem Your Technology Partner

AE

DWG NO: PKGML00001

APP'D

CHECKED

DRAWN

DATE

2007-JUN-23

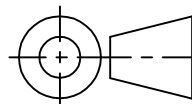

DWG TITLE:

MLP QUAD FAMILY PACKAGE OUTLINE

Page 13 of 15

e= 0.50 Pitch

Variation Symbol	VMMD-3NJ3	VMMD-NJ1	VNND-2NJ1	VNND-3NJ1	VNND-3NJ2	VPHD-NJ1	VPPD-NJ1	VRRD-NJ1	VRRD-NJ2	Note
	WMMD-3NJ3	WMMD-NJ1	-	WNND-3NJ1	WNND-3NJ2	WPHD-NJ1	WPPD-NJ1	WRRD-NJ1	WRRD-NJ2	
D BSC	9.00	9.00	10.0	10.00	10.00	11.00	11.00	12.00	12.00	
E BSC	9.00	9.00	10.0	10.00	10.00	5.00	11.00	12.00	12.00	
D1 BSC	---	---	---	---	---	---	---	---	---	
E1 BSC	---	---	---	---	---	---	---	---	---	
D2	MIN	7.45	7.00	6.60	5.75	8.45	8.25	9.45	6.60	10.45
	NOM	7.60	7.15	6.75	5.90	8.60	8.40	9.60	6.75	10.60
	MAX	7.70	7.25	6.85	6.00	8.70	8.50	9.70	6.85	10.70
E2	MIN	7.45	7.00	6.60	5.75	8.45	2.25	9.45	6.60	10.45
	NOM	7.60	7.15	6.75	5.90	8.60	2.40	9.60	6.75	10.60
	MAX	7.70	7.25	6.85	6.00	8.70	2.50	9.70	6.85	10.70
L	MIN	0.30*	0.45	0.30*	0.30*	0.30*	0.30	0.30	0.30	0.30
	NOM	0.40	0.55	0.40	0.40	0.40	0.40	0.40	0.40	0.40
	MAX	0.50	0.65	0.50	0.50	0.50	0.50	0.50	0.50	0.50
N	64	60	72	72	72	56	80	88	88	
ND	16	15	18	18	18	20	20	22	22	
NE	16	15	18	18	18	8	20	22	22	
NOTES	1,2,10	1,2,10	1,2,10	1,2,10	1,2,10	1,2,10	1,2,10	1,2,10	1,2,10	1,2,10
REF	---	---	---	---	---	---	---	---	---	
ISSUE	---	---	---	---	---	---	---	---	---	

Variation Symbol										Note
D BSC										
E BSC										
D1 BSC										
E1 BSC										
D2	MIN									
	NOM									
	MAX									
E2	MIN									
	NOM									
	MAX									
L	MIN									
	NOM									
	MAX									
N										
ND										
NE										
NOTES										
REF										
ISSUE										

FOR REVISION UPDATE PLEASE REFER TO HISTORY OF CHANGES.



AE

DWG NO: PKGML00001

APP'D

CHECKED

DRAWN

DATE

2007-JUN-23

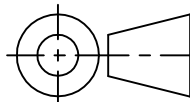

DWG TITLE:

MLP QUAD FAMILY PACKAGE OUTLINE

Page 14 of 15

Notes:

1. Dimensioning and tolerancing conform to ASME Y14.5m-1994.
2. All dimensions are in millimeters while angle is in degrees (°).
3. N is the total number of terminals.
4. The terminal #1 identifier and terminal numbering convention shall conform to JEDEC publication 95, SPP-002. Details of terminal #1 identifier are optional, but must be located within the zone indicated. The terminal #1 identifier may be either a mold or marked feature.
5. Dimension b applies to metallized terminal and is measured between 0.15mm and 0.30mm from the terminal tip. If the terminal has the optional radius on the other end of the terminal, the dimension b should not be measured in that radius area.
6. ND and NE refer to the number of terminals on each D and E side respectively.
7. Depopulation is possible in a symmetrical fashion.
8. Figure 1 is shown for illustration only. It does not represent any specific variations.
9. All variations may be constructed per figure 1. Variations may alternately be constructed between square shape or rectangular shape per D and E.
10. For a complete set of dimension for each variations, please refer to page 2.1 of 5.
11. Unilateral coplanarity zone applies to the exposed heat sink slug as well as the terminals.
12. Depending on the method of lead termination at the edge of the package, pull back (L1) may be present. L minus L1 to be equal to or greater than 0.33mm.
13. For variations with more than one lead count for a given body size and terminal pitch, each lead count for that variation is denoted by a dash number i.e -1,-2.
14. Variation with a Star (*) symbol refers to variations which are not currently JEDEC registered.

FOR REVISION UPDATE PLEASE REFER TO HISTORY OF CHANGES.



AE	DWG NO: PKGML00001			DWG TITLE:
	APP'D			MLP QUAD FAMILY PACKAGE OUTLINE
	CHECKED			
	DRAWN			
	DATE	2007-JUN-23		
			Page 15 of 15	